

How to Make a Dog Sled Adventure Playset



Create your own dog sled adventure with Molly, Tooeey, and Trini!

Follow the steps on the next pages to make a dog sled out of paper, complete with dog team and passengers: Molly, Tooeey, and Trini. Where will your imagination take them?

Materials

- Printouts of sled pieces, dog team, and passengers
- Crayons or markers
- Scissors
- Empty cereal box (or other heavy-weight paper or cardboard)
- Glue or glue stick
- Pencil
- Tape
- String or yarn

My dad races in the Iditarod. One day, I will too!



Make Your Dog Sled

1. Color the sled pieces on page 3.
2. Cut the cereal box so that you have a piece of flat cardboard.
3. Glue the printout with the sled pieces onto the printed side of the cereal box cardboard. Smooth out any bubbles.
4. Use the tip of a pencil to punch a hole in the dog sled where indicated.
5. When the glue is dry, cut out the sled, the brush bow, and the handlebar.
6. Fold up each side of the sled, with the colored sides facing out.
7. Use tape to attach the brush bow to the runners at the front of the sled.
8. Use tape to attach the handlebar to the top rail on each side of the sled.

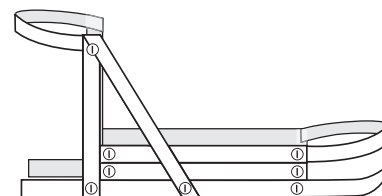

A dog sled is a sled pulled by specially trained dogs over ice or through snow. The Alaskan Husky is the most commonly used sled dog.

Dog sleds come in many designs, shapes, and sizes. Traditionally, dog sleds have transported people and supplies and were a critical part of everyday life in the Arctic. They are also used for fun and sport. The most famous dog sled race is the Alaskan Iditarod Trail Sled Dog Race.

pbskids.org/molly

Powered by a Ready To Learn Grant



HOMER
kid powered learning

T. Rowe Price
COLLEGE SAVINGS PLAN
Offered by THE EDUCATION TRUST OF ALASKA

IKEA

WGBH
Kids



CBC Kids

The contents of this program were developed under a grant from the Department of Education. However, those contents do not necessarily represent the policy of the Department of Education, and you should not assume endorsement by the Federal Government. The project is funded by a Ready To Learn grant (PR/AWARD No. U295A150003, CFDA No. 84.295A) provided by the Department of Education to the Corporation for Public Broadcasting.

Funding for MOLLY OF DENALI™ is provided by a Ready To Learn Grant from the U.S. Department of Education; the Corporation for Public Broadcasting, a private corporation funded by the American People; and by public television viewers. Additional funding made possible with the participation of the Province of British Columbia Production Services Tax Credit. Corporate funding provided by Homer, the T. Rowe Price College Savings Plan, and IKEA®.

MOLLY OF DENALI is produced by WGBH Kids and Atomic Cartoons in association with CBC Kids. PBS KIDS and the PBS KIDS Logo are registered trademarks of Public Broadcasting Service. Used with permission.

Molly of Denali, and related characters and indicia are trademarks and copyright 2019 WGBH Educational Foundation. All rights reserved.



Make Your Dog Team

1. Cut out the dog team on page 4.
2. Fold in half along the center fold line to form two rows of dogs.
3. Fold the two bottom pieces under the dog team's feet and tape together to form a stable base.
4. Use the tip of a pencil to punch a hole at the back of the dog team where indicated.
5. Tie the string from the dog sled to the dog team. Now the dog team is ready to pull the sled!

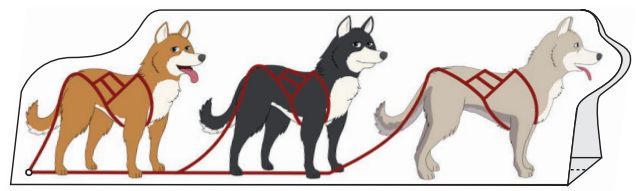

Make Molly, Tooeey, and Trini

1. Cut another piece of flat cardboard from the cereal box.
2. Glue the page with the characters (page 5) onto the printed side of the cereal box cardboard. Smooth out any bubbles.
3. When the glue is dry, cut out each character.
4. Fold the long tabs at each character's feet into a loop behind the character. Tape the two ends together to form a circular base to help the characters stand upright.
5. Now Molly, Tooeey, and Trini can hop aboard the sled for some great adventures!



Let's Go!

Ready for a dog sled adventure? Whether you imagine that you're moving people from place to place, transporting supplies, or participating in a dog sled race, you need to know common commands to get your dog team where you want it to go.

Hike! Start moving, or go faster.

Easy! Slow down.

Gee! Turn right.

Straight ahead! Move forward.

Haw! Turn left

On by! Pass.

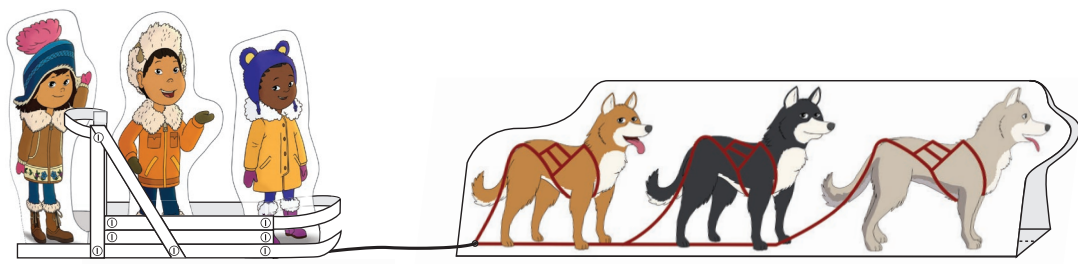

pbskids.org/molly

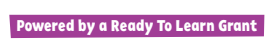

The contents of this program were developed under a grant from the Department of Education. However, those contents do not necessarily represent the policy of the Department of Education, and you should not assume endorsement by the Federal Government. The project is funded by a Ready To Learn grant (PR/AWARD No. U295A150003, CFDA No. 84.295A) provided by the Department of Education to the Corporation for Public Broadcasting.

Funding for MOLLY OF DENALI™ is provided by a Ready To Learn Grant from the U.S. Department of Education; the Corporation for Public Broadcasting, a private corporation funded by the American People; and by public television viewers. Additional funding made possible with the participation of the Province of British Columbia Production Services Tax Credit. Corporate funding provided by Homer, the T. Rowe Price College Savings Plan, and IKEA®.

MOLLY OF DENALI is produced by WGBH Kids and Atomic Cartoons in association with CBC Kids. PBS KIDS and the PBS KIDS Logo are registered trademarks of Public Broadcasting Service. Used with permission. Molly of Denali, and related characters and indicia are trademarks and copyright 2019 WGBH Educational Foundation. All rights reserved.

SLED PIECES

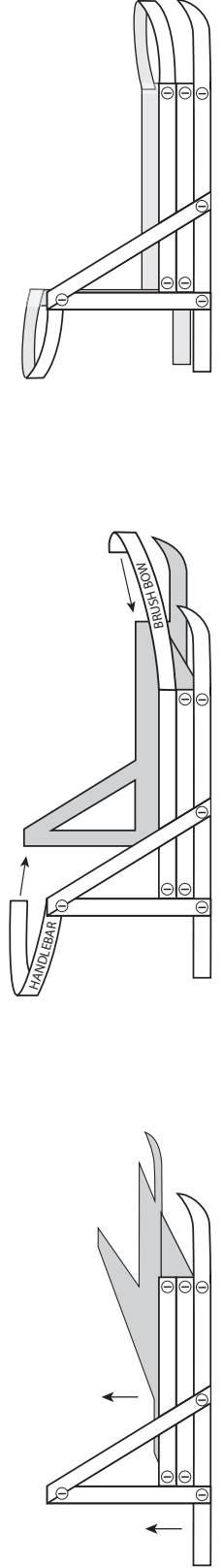
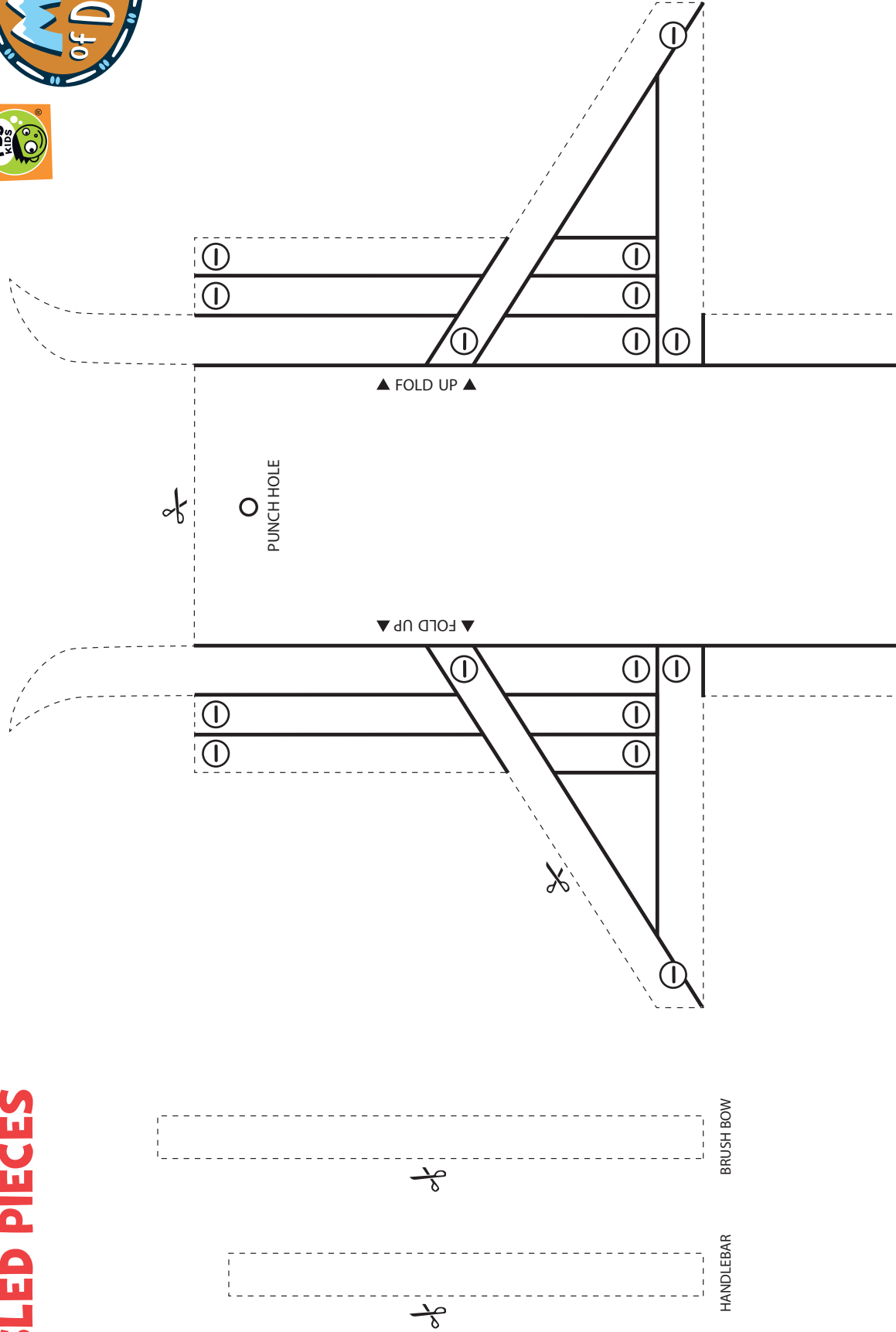

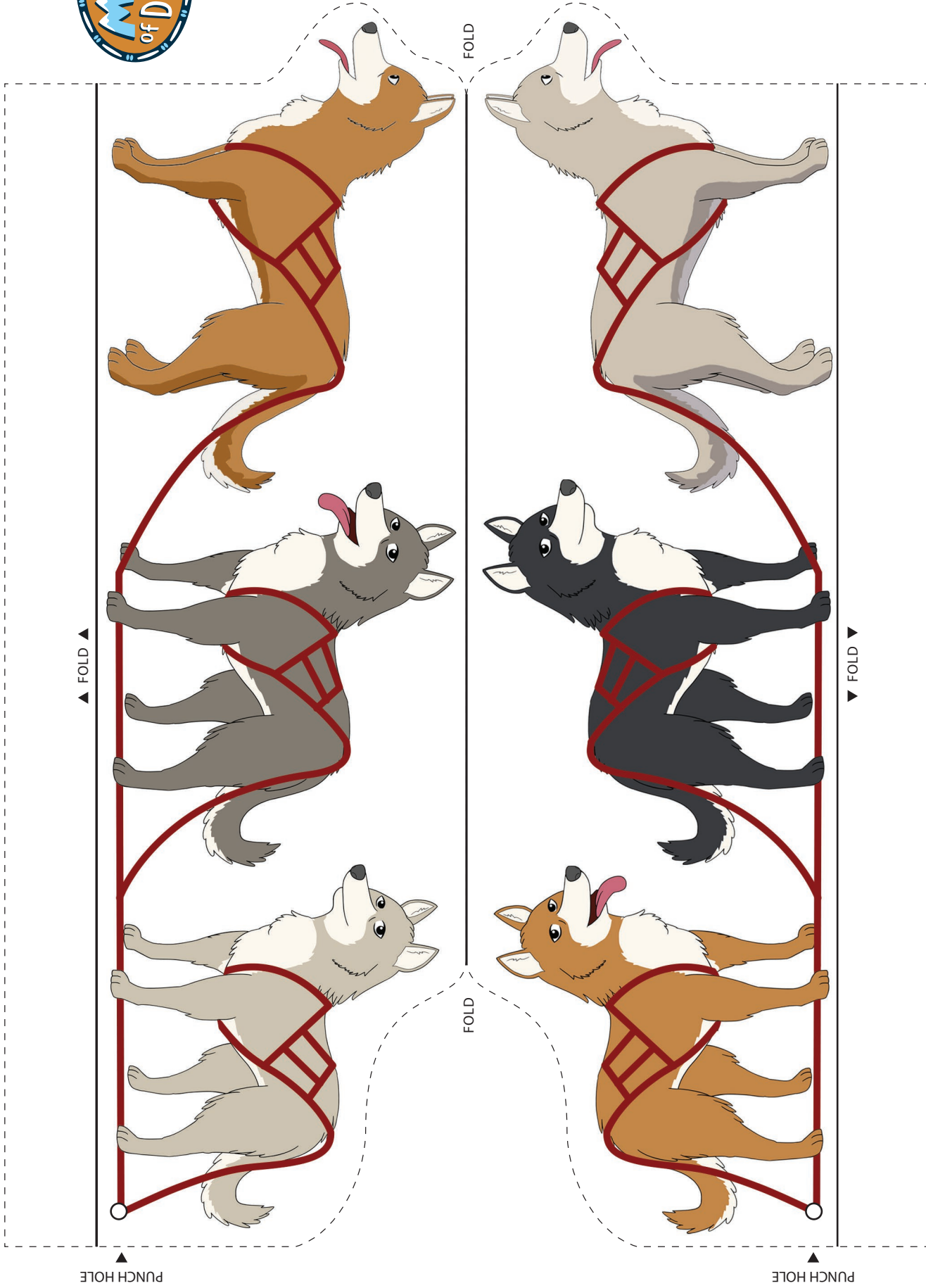

DOG TEAM

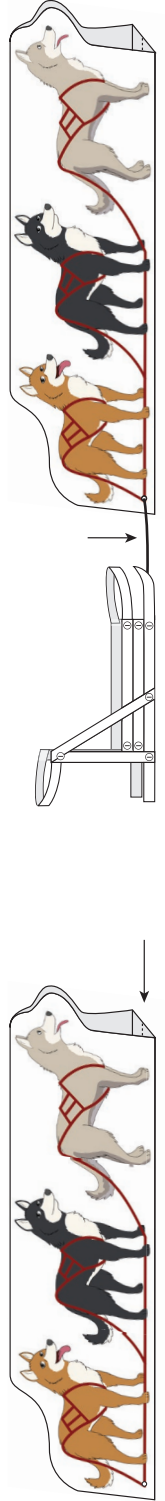

PASSENGERS

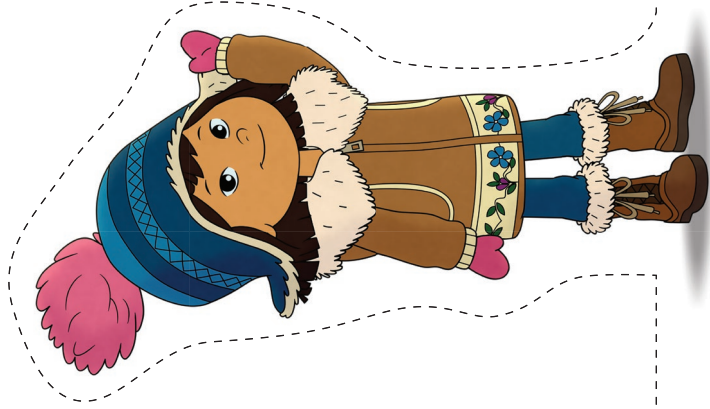

Molly

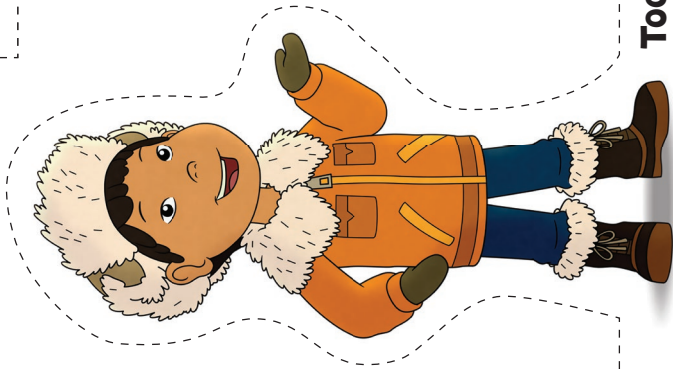

Tooley

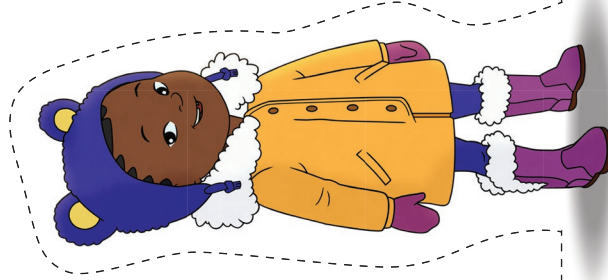

Trini